

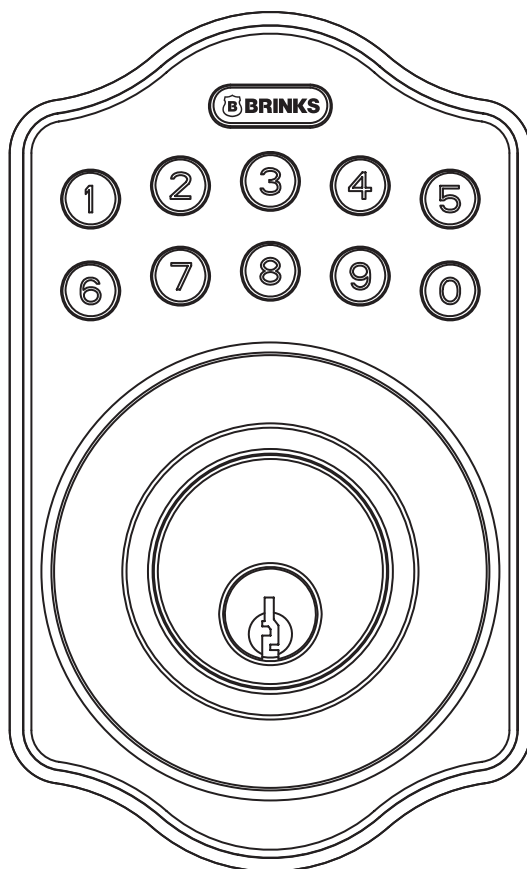

BRINKS

A TRUSTED NAME IN SECURITY SINCE 1859™



INSTALLATION AND OPERATION MANUAL FOR DIGITAL DEADBOLT LOCK

DIGITAL DEADBOLT LOCK

Questions? Call
1-800-562-5625
for help.

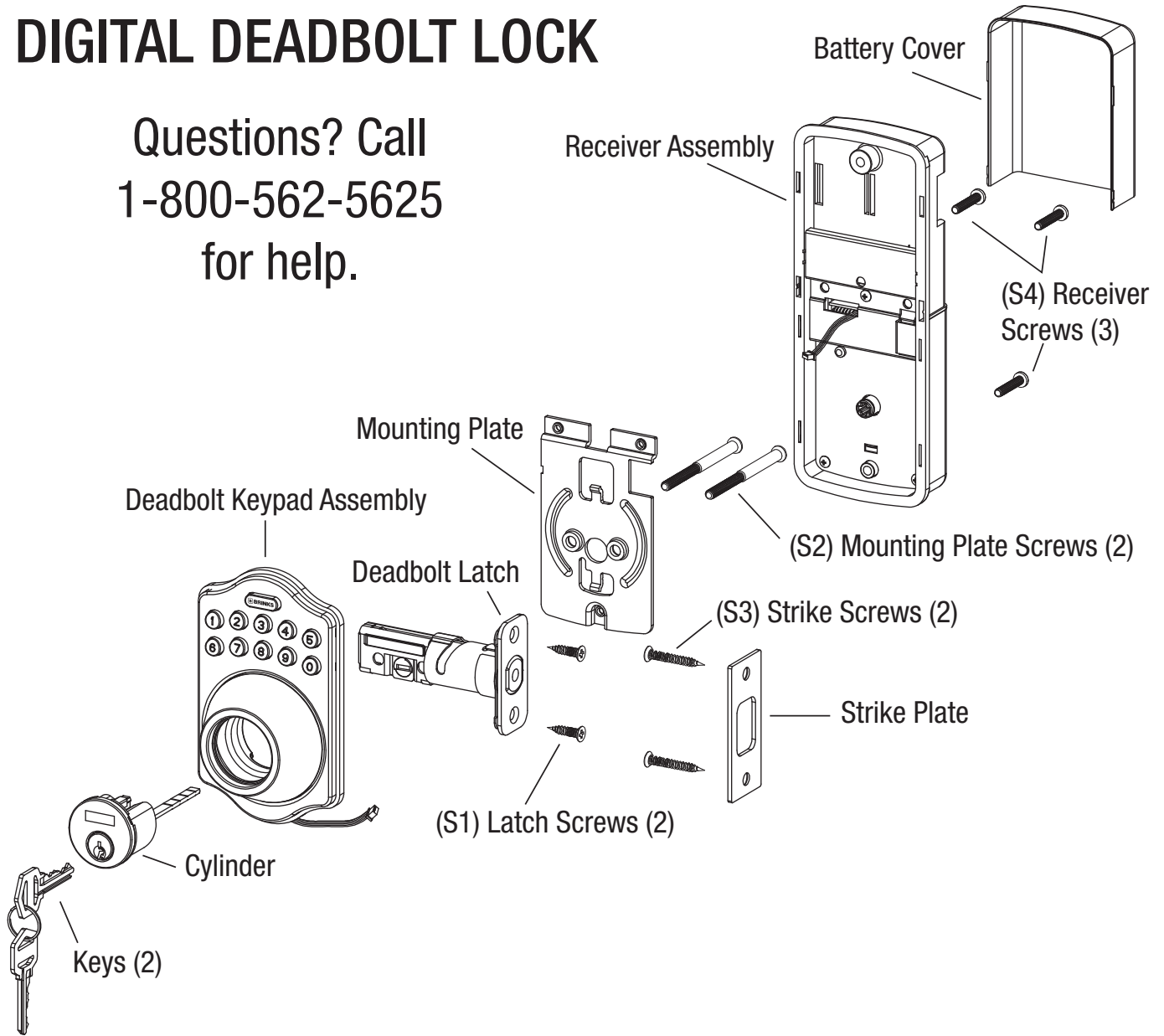

TOOL REQUIRED :  



USE OF A POWERED
SCREWDRIVER IS
NOT RECOMMENDED

INSTALLATION INSTRUCTIONS

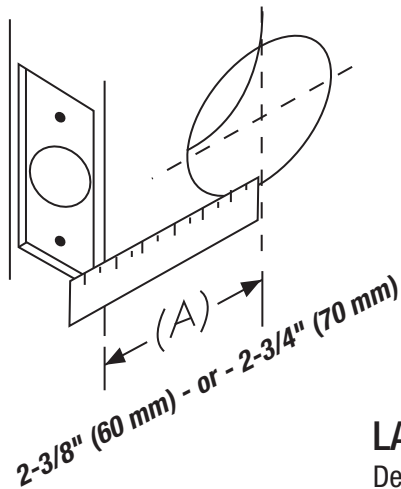

BACKSET AND LATCH ADJUSTMENT

Backset is the distance from door edge to center of hole on door face. (See Illustration) The latch can be adjusted to fit either a 2-3/8" (60 mm) or a 2-3/4" (70 mm) backset. The latch is set at a 2-3/8" backset from the factory.

For a replacement installation, measure this distance on your door. For a new installation, you may choose either backset, although 2-3/8" (60 mm) is recommended for residential doors.

LATCH BACKSET ADJUSTMENT :

Determine if the latch needs to be adjusted to the 2-3/4" (70 mm) backset. To adjust, rotate the latch until it stops. Reverse the direction to return to the 2-3/8" (60 mm) backset.

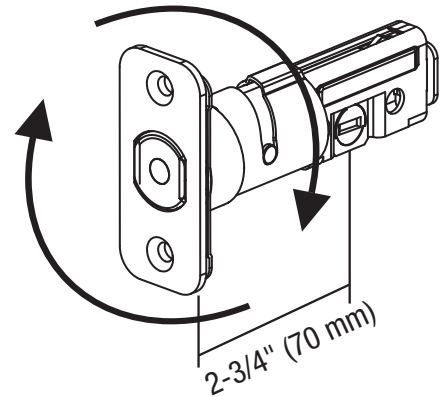

Use the following steps to prepare your door for a new installation, or to verify dimensions for a replacement installation.

1 Mark Door with Template

- Mark the centerline for the deadbolt about 44" (1120 mm) from the floor, or about 5-1/2" (140 mm) above the center of an existing knob or lever.
- Apply the template to the door with the dotted fold line on the door edge.
- Select the 2-3/8" (60 mm) or 2-3/4" (70 mm) backset and mark the center for the hole for the deadbolt on the door face.
- Mark the center for the latch hole on the door edge according to the thickness of your door.

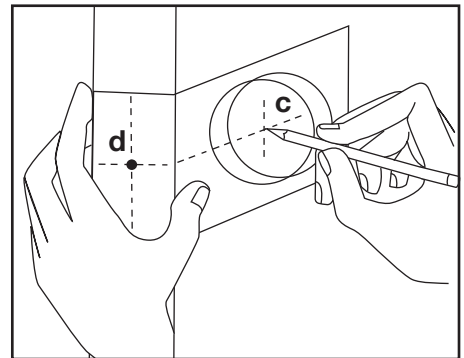

2 Drill Holes

- Drill a 2-1/8" (54 mm) hole on the door face from both sides to avoid wood splitting.
- Drill a 1" (25.4 mm) hole in the door edge for the latch.

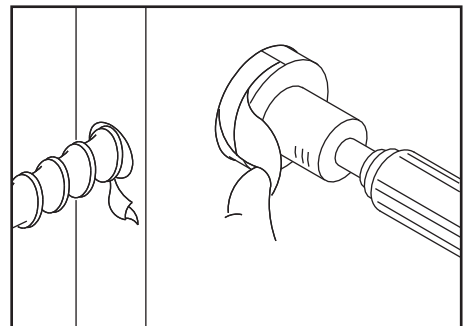

INSTALLATION INSTRUCTIONS (Continued)

3 Install Latch

- Insert latch into hole, mark outline of faceplate, and chisel 1/8" (3 mm) deep or until the faceplate is flush with the door edge.
- Mark latch screw holes and drill two 1/8" (3 mm) pilot holes for the latch screws.
- Install latch into the hole in the edge of the door with the slotted cam at the bottom.
- Insert two (S1) latch screws through the holes in the faceplate and tighten firmly.

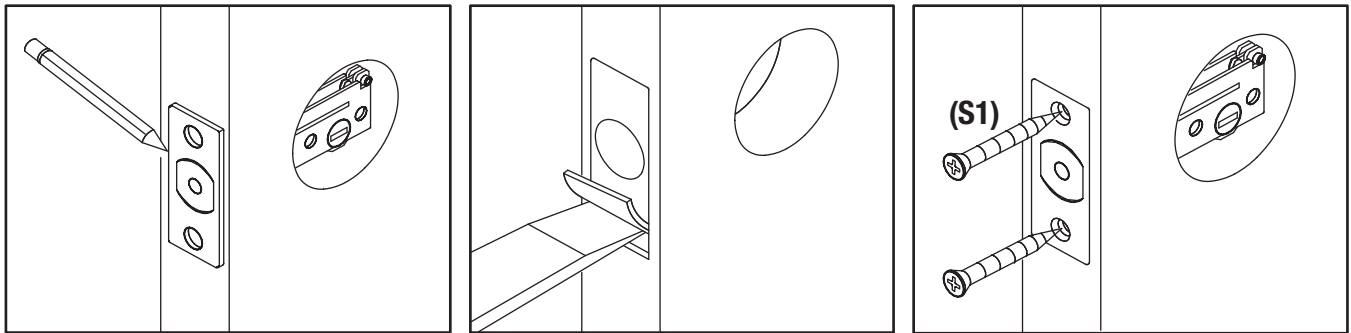

4 Install Strike

- Mark centerline on the door jamb exactly opposite the latch hole in the door edge.
- Drill a 1" (25.4 mm) hole 1-1/8" (29 mm) deep in the door jamb.
- Position the strike plate over the 1" hole and mark the outline. Chisel about 1/16" (1.6 mm) deep or until strike plate is flush with door jamb.
- Mark strike plate screw holes and drill two 1/8" (3 mm) pilot holes for the (S3) strike plate screws. Place the strike plate in the prepared position in the door jamb, aligning the screw holes in the strike plate over the pilot holes. Insert two (S1) latch screws through the holes in the strike plate and tighten firmly.

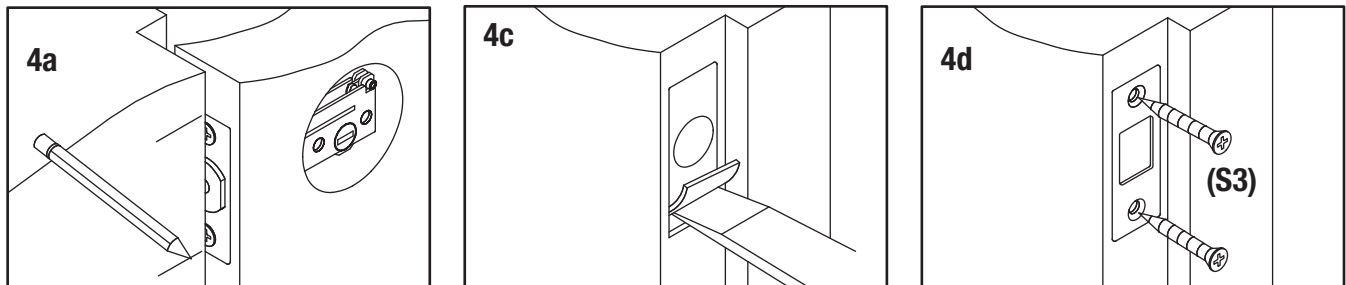

INSTALLATION INSTRUCTIONS (Continued)

Note: Work with the door open until the lock is installed and tested to avoid an accidental lockout.

5 Install Keypad Assembly

- Make sure that the latch bolt is retracted (unlocked).
- Insert the Cylinder into the Keypad Assembly and orient the Tailpiece in a **horizontal position**.
- Pass the IC Wire under the deadbolt and insert the Tailpiece through the slotted cam of the latch and place the Keypad Assembly against the door.

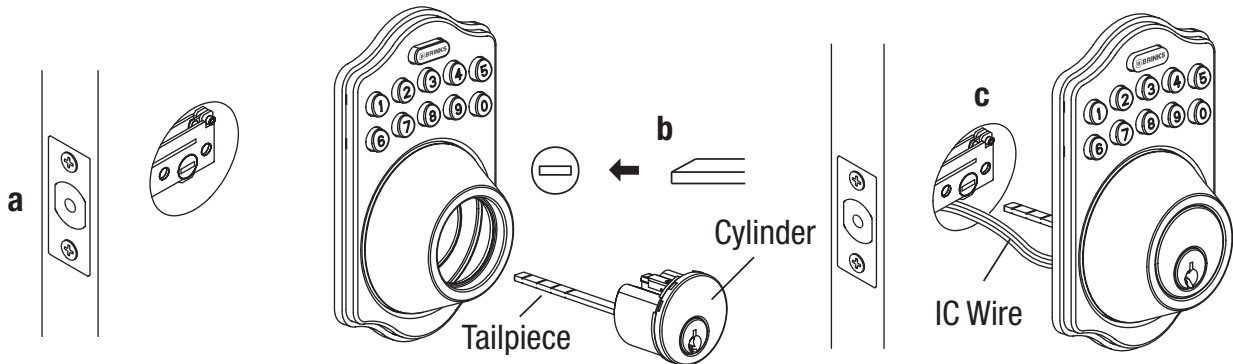

6 Install Inside Mounting Plate

- Pass the IC Wire through the opening in the Mounting Plate as shown.
- Insert 2 (S2) Mounting Plate Screws through the holes in the plate and thread into the cylinder. Tighten firmly.
- If the Mounting Plate or Keypad Deadbolt Assembly is not straight, loosen the screws and adjust its position and tighten the screws again.

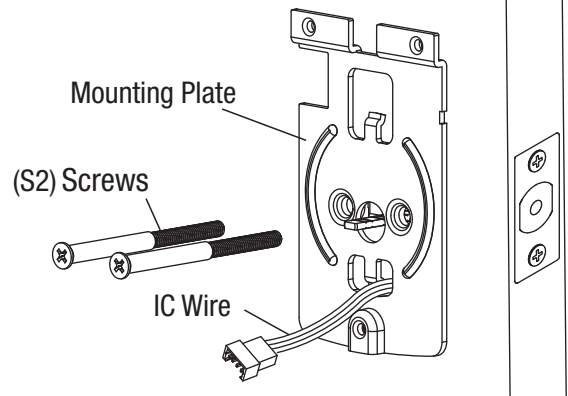

7 Identify Door Handing

Face the door from outside. The door is left-handed if the hinges are on the left hand side of the door, whereas, the door is right-handed if the hinges are on the right hand side of the door.

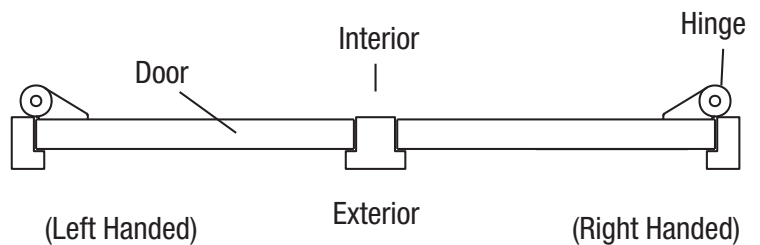

8 Adjust The Turnpiece

- Turn the Turnpiece left (Counterclockwise) for installation on a right-handed door.
- Turn the Turnpiece right (Clockwise) for installation on a left-handed door.

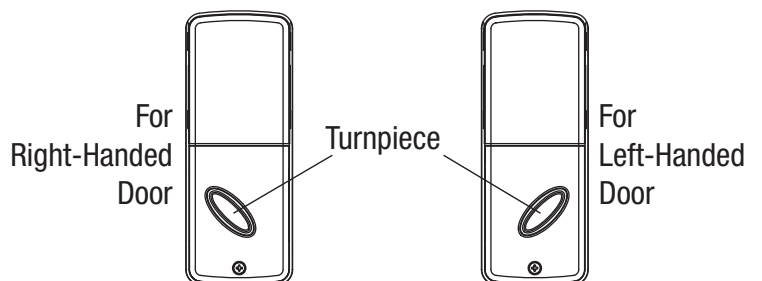

INSTALLATION INSTRUCTIONS (Continued)

9 Install Receiver Module

- a. Remove the battery cover by first pushing it up until the tabs on the cover are aligned with the slots in the module housing. Then pull the cover out. To reinstall the battery cover, reverse these steps.
- b. Connect the exterior IC Wire to the interior IC Wire by pushing them together. See the illustration for the connector orientations.
- c. Place the Receiver Module against the door, making sure that the Turnpiece engages the slot in the Turnpiece.
- d. Check deadbolt operation by rotating the Turnpiece back and forth. The bolt should extend and retract freely. If it does not, the Turnpiece may be in the wrong orientation. See Step 8.
- e. After checking proper mechanical operation, attach the Receiver Module to the Mounting Plate using 3 (S4) Receiver Screws.
- f. Insert 4 **NEW** AA 1.5V alkaline batteries using the diagram in the battery compartment and replace the battery cover.

 **DO NOT MIX OLD AND NEW BATTERIES!**

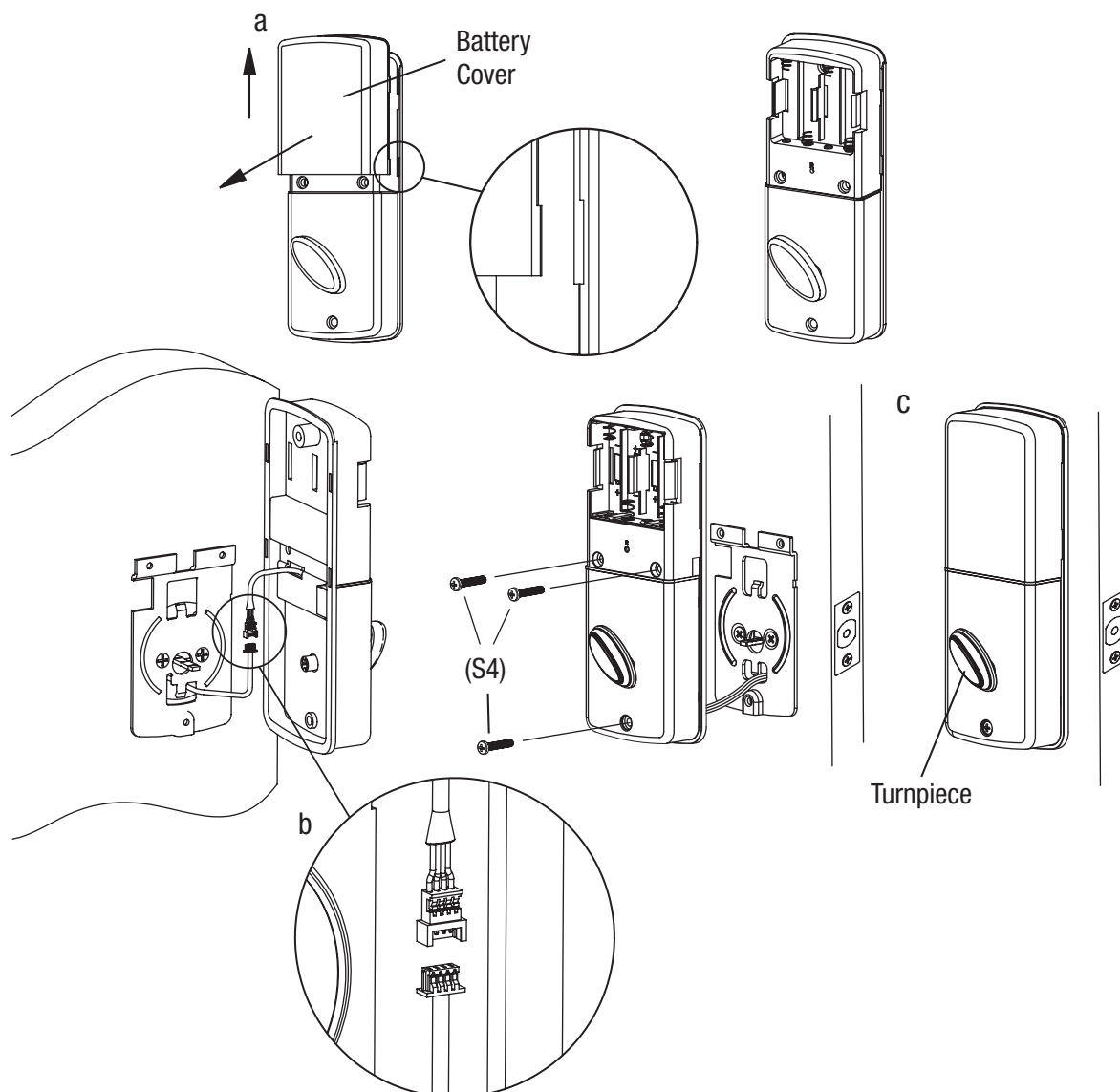

CONTROL DESCRIPTIONS

1  **Programming Button**

Used for entering codes, clearing errors and setting functions.
Also used to lock the digital deadbolt.
LED's light up this button for visual feedback.
Press this button before entering codes to light up number pad.

2 **Number Buttons**

Used to enter codes and data.

3 **Cylinder**

Retract/Extend the latch bolt into unit.

4 **Gasket**

Prevents water leakage into unit.

5 **Battery Cover**

Remove the cover to replace batteries or restore default settings.

6 **Battery Compartment**

Holds 4 AA 1.5V Alkaline batteries.

7 **R Button**

Restores default settings.

8 **Turnpiece**

Retract/Extend the latch bolt from interior.

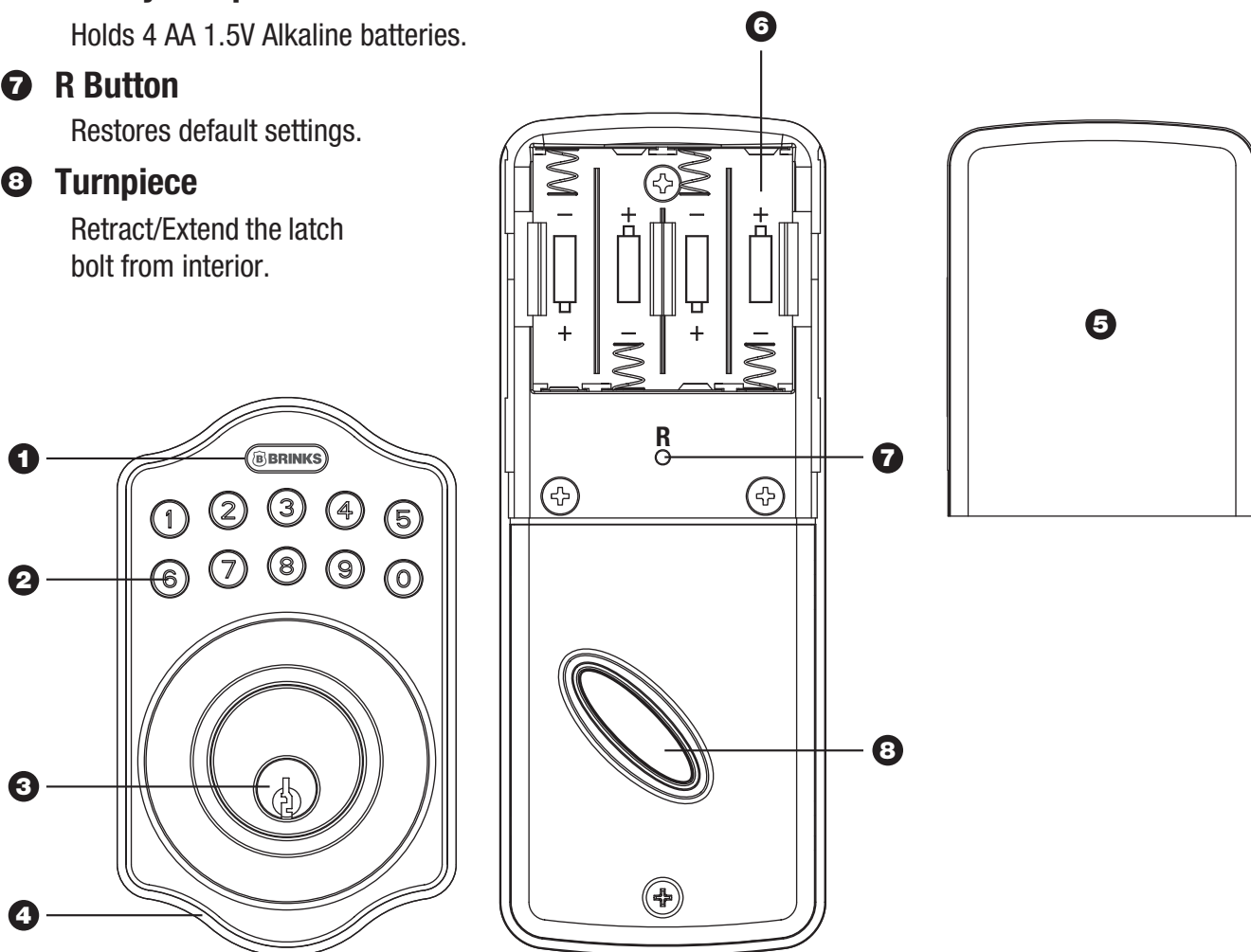







AUDIO AND VISUAL FEEDBACK SIGNALS

BRINKS Button Indicator Sounds

	1 Beep	Successful Operation
	2 Long Beeps	Successful Programming
	3 Beeps	Operation Error
	5 Beeps	Code Input Error. System Shuts Down. See Steps 11e.
	10 Rapid Beeps	Low Battery Power

BRINKS Button Indicator Lights

	Flashes Green Once	Successful Operation
	Flashes Green Twice	Successful Programming
	Flashes Red 3 Times	Operation/Programming Error
	Flashes Red 5 Times	Code Input Error. System Shuts Down. See Step 11e.
	Flashes Red 10 Times	Low Battery Power
	Flashes Orange 3 Times	Default Setting Restoration Successful
	Flashes Orange Slowly	In Programming Mode

PROGRAM & OPERATION GUIDE

IMPORTANT: NOW THAT THE DIGITAL DEADBOLT IS INSTALLED, YOU MUST COMPLETE STEP 10 BEFORE THE ELECTRONIC FEATURES OF THIS PRODUCT WILL WORK. ALL PROGRAMMING MUST BE DONE WITH THE BOLT RETRACTED. LEAVE THE DOOR OPEN WHILE PROGRAMMING TO PREVENT ACCIDENTAL LOCKOUT. READ THE PROGRAMMING BASICS BELOW BEFORE PROCEEDING TO STEP 10.



Programming Code (PC)

- a. The default PC is 0000. (For better security, please change it after completing Step 10.)
- b. The PC is the administrative code for entering lock functions. It does not operate the lock.

User Code (UC)

- a. The default UC is 1234. (For better security, please delete it after completing Step 10.)
- b. Up to 6 User Codes can be stored.
- c. A UC is used to unlock the deadbolt.

Programming Basics

- a. All programming (entering functions) has to be done with the deadbolt unlocked.
- b. All functions begin with entering the Programming Code.
- c. The  Programming Button is used to enter data.
- d. Each step of a function programming sequence needs to be completed within 6 seconds.
- e. During a programming sequence, the  Programming Button turns orange to indicate that you can proceed. See the Visual and Audio Feedback Signals table for more indicators.

10 Detect Left/Right Hand Door Installation

!!! NOTE: Always run this step on first installation or after a default setting restoration. The motor will not operate and no other programming function can be entered before completing this step.

- a. Enter this sequence on the keypad:





(The PC will always be 0000 for this step.)

- b. You will hear the motor run and then 2 beeps and the  button will flash green twice.

PROGRAM & OPERATION GUIDE (Continued)



11 Operation

- With Step 10 complete, the digital deadbolt can be operated electronically.
- To lock (extend the bolt), press the  button. You will hear one beep and the  button will flash green once.
- To unlock, enter a UC and then press the  button.

ENTER UC → 

- For initial setup, the only UC is 1234. The bolt will retract and you will hear one beep and the  button will flash green once.
- If an incorrect UC is entered 5 times, the lock will time out for 45 seconds for security purposes. The lock can be opened by key during this time.

12 Add A New User Code (UC)

ENTER PC →  → 1 →  → ENTER NEW UC → 

- UC is 4-10 digits.
- Up to 6 User Codes can be stored.
- Test new UC before closing door.

13 Delete An Existing User Code (UC)

ENTER PC →  → 2 →  → ENTER UC TO BE DELETED → 

- It is recommended to delete the 1234 default UC.
- A UC must be entered before the digital deadbolt will operate electronically.

14 Delete All User Codes At Once

ENTER PC →  → 3 → 

Note: A new UC must be entered before the digital deadbolt will operate electronically.

PROGRAM & OPERATION GUIDE (Continued)

15 Changing Programming Code



- a. PC is 4-10 digits.
- b. It is recommended to change the default 0000 PC.
- c. Test new PC by using it to enter another function.

16 Toggle Autolock On/Off



- a. The Autolock feature automatically locks the deadbolt after a specified time delay.
- b. The default time delay is 30 seconds.
- c. Enter the programming sequence again to turn Autolock OFF.

17 Set Autolock Time Delay



- a. The Autolock time delay can be set between 10 and 99 seconds.
- b. The default time delay is 30 seconds.
- c. Entering a new time delay does not automatically turn on the Autolock function.

18 Toggle Mute ON/OFF



- a. In normal operation, the lock gives audio feedback for almost every action. This function will mute those sounds.
- b. The LED indicator lights will still give visual feedback if the sound is muted.
- c. The sound can be turned back on by entering this sequence again.

PROGRAM & OPERATION GUIDE (Continued)

19 Temporarily Disable All User Codes



- This will not delete, but will temporarily disable all User Codes.
- The deadbolt will not operate electronically while the User Codes are disabled.
- Enter the programming sequence again to enable the User Codes.

20 Create A One Time User Code (OTC)



- OTC is 4 - 10 digits. The OTC does not take one of the 6 memory locations for User Codes.
- This function creates a User Code that can only be used once and is automatically deleted when used.
- This One Time User Code may be useful in a situation where someone, such as a repairman, needs access but will not require access on a regular basis.

21 Restore Original Lock Settings

- At some point, you may want to reset the digital deadbolt to its original, default settings. This may be because you have forgotten the Programming Code (PC) or the User Codes.
- To reset the lock, remove the battery cover from the Receiver Module and locate the R button (7) as shown on the diagram on the Control Descriptions page.
- Using a pen or unfolded paper clip, press the R button for over 5 seconds until you hear 3 long beeps.
- The lock is now reset. The PC is the original 0000, and the only UC is 1234.
- You must now run the Door Handing Detection Function described in Step 10 before any other function.

22 Low Battery Warning

- Under normal operation, the alkaline batteries should last about a year.
- If you hear 10 rapid beeps corresponding with 10 red flashes after pressing the  programming button, that's an indication that the batteries need to be replaced soon.



REPLACE WITH 4 NEW AA ALKALINE BATTERIES. DO NOT MIX OLD AND NEW BATTERIES.

- All settings are retained in the memory when the batteries are removed and replaced.
- The lock can still be operated by key even if the batteries are completely dead.

TROUBLESHOOTING GUIDE (Continued)

1. Problem: The bolt can't be extended by rotating the Turnpiece or using the Key

Problem: The Turnpiece was installed out of phase with the handing of the door.

Solution: Refer to Step 8 and reinstall the receiver Module with the Turnpiece oriented correctly.

2. Problem: When attempting to lock the deadbolt electronically, you receive an error indication, 3 beeps and 3 red flashes (no beeps if Mute function is activated)

Problem: The bolt is not extending fully.

Solution: Check the hole behind the strike plate. It must be at least 1" (25.4 mm) deep. Also check the alignment of the strike plate opening with the bolt. There may be interference, especially if the door has warped due to a change in the weather. You may need to adjust the position of the strike plate.



3. Problem: When attempting to unlock the deadbolt electronically, you receive an error indication, 3 beeps and 3 red flashes (no beeps if Mute function is activated).

Problem: The bolt is not retracting fully.

Solution: As in the problem with locking the bolt, the bolt may be binding against the strike plate. There may be interference, especially if the door has warped due to a change in the weather. You may need to adjust the position of the strike plate.

4. Problem: You receive a programming error indication, 3 beeps and 3 red flashes (no beeps if Mute function is activated), when attempting to enter a function.

Problem: The Programming Code (PC) is incorrect or you are attempting to enter the sequence too quickly.

Solution: 1. Check your PC again. You may have changed it recently. If you have forgotten it, you can Reset the default settings. 2. If the PC is current, then you may be entering the programming sequence too quickly. After entering the PC and pressing the  programming button, wait for the  button to begin flashing orange before proceeding.

5. Problem: After the installation of the batteries, the door can not be locked by pressing the programming button and 3 beeps are heard.

Problem: The Door Handing Detection Function has not been run or is not complete.

Solution: Refer to Step 10 and run the Door Handing Detection Function.

TROUBLESHOOTING GUIDE (Continued)

6. Problem: After the installation of the batteries, there is no response when you press any button and no beeps are heard.

Problem: The unit is not receiving power.

Solution: Check the cable connection and the polarity of the batteries. Also make sure the batteries are not dead.

7. Problem: The lock has been operating, but suddenly the latch bolt locks up and pressing the  programming button or entering a UC results in no action.

Problem: The unit has lost its handing orientation and the motor does not know which way to operate.

Solution: Remove a battery and press a few buttons on the keypad to discharge any residual electrical signal. Replace the battery; the unit will automatically re-detect the door handing.

TECHNICAL INFORMATION AND RECOMMENDATIONS

The digital deadbolt lock can be installed in doors ranging from 1-3/8" (35mm) to 2" (51mm) thick. Uses 4 AA (1.5V) batteries to power the DC Motor.

Alkaline batteries are recommended for best performance with a DC Motor.

























Rechargeable batteries are not recommended.



**DO NOT MIX BATTERY TYPES. DO NOT MIX OLD AND NEW BATTERIES.
DISPOSE OF OLD BATTERIES PROPERLY.**

Use only warm water to clean the lock. Chemicals and abrasives may damage the finish.

PROGRAMMING FUNCTION QUICK REFERENCE TABLE

FUNCTION	STEPS (Enter Data In The Sequence Shown from left to right)									REMARKS
Detect Left Or Right Hand Door Installation	Enter Programming Code		Press 0				Run this process before setting up any other function after installation or after restoring the original lock settings. The deadbolt should be unlocked to run this or any other function.			
Add A New User Code (UC)	Enter Programming Code		Press 1		Enter New User Code		Up to 6 User Codes can be saved. A User Code can be 4 - 10 digits in length.			
Delete An Existing User Code (UC)	Enter Programming Code		Press 2		Enter New User Code to be deleted		Delete an individual User Code. It is a good security practice to delete the default 1-2-3-4 code.			
Delete All User Codes At Once (UC)	Enter Programming Code		Press 3				The Autolocking Function and locking using the BRINKS button on the keypad will be disabled when all User Codes are deleted. The lock can only be operated by key until a User Code is added.			
Change Programming Code (PC)	Enter Programming Code		Press 4		Enter New Programming Code		It is a good security practice to change from the default 0-0-0-0 Programming Code to a unique code.			
Toggle Autolock On/Off	Enter Programming Code		Press 5				The default Autolock setting is OFF. Use this function to toggle between ON and OFF for the Autolock feature.			
Set Autolock Time Delay	Enter Programming Code		Press 6		Enter 2-Digit Number (10-99 Seconds)		The default Autolock delay is 30 seconds. You can set the time between 10 and 99 seconds.			
Toggle Mute On/Off	Enter Programming Code		Press 7				The default Mute setting is OFF. Use this function to toggle between ON and OFF for the Mute feature.			
Enable/Disable All User Codes (UC)	Enter Programming Code		Press 8				The Autolocking Function and locking using the BRINKS button on the keypad will be disabled when the User Codes are disabled. The lock can only be operated by key until the User Codes are enabled again. Use this function to enable the User Codes again.			
Create a One Time User Code (UC)	Enter Programming Code		Press 9		Enter New One Time User Code		Use this function to add a User Code that can be used only one time.			
Restore Original Lock Settings	Press "Reset" Button For Over 5 Seconds									Press the "P" button for over 5 seconds until you hear 3 long beeps. This will restore the lock to the original default factory settings. You will need to run the Door Handling Detection Function in Step 10 again after restoration.

Questions? Call 1-800-562-5625 for help.



⚠WARNING: This product can expose you to chemicals including lead, which is known to the State of California to cause cancer and birth defects or other reproductive harm. For more information go to www.P65Warnings.ca.gov.

BRINKS A TRUSTED NAME IN SECURITY SINCE 1859 and all related logos are trademarks or registered trademarks of Brink's Network, Inc, and are used with permission.

FULL LIFETIME WARRANTY - This product is fully warranted to be free of defects in material and workmanship for the life of the product. If a defect in material or workmanship occurs, call 800-562-5625 for instructions on how to have it replaced or repaired free of charge. This warranty is null and void if the product was used for purposes for which it was not designed, is abused, misused, modified or improperly installed, operated, maintained, and/or repaired. NOT LIABLE FOR INCIDENTAL, INDIRECT, OR CONSEQUENTIAL DAMAGES. Some states do not allow the exclusion or limitation of incidental or consequential damages, so the above limitation or exclusion may not apply to you. This warranty gives you specific rights, and you may also have other rights that vary from state to state.



Hampton Products International Corp.
50 Icon, Foothill Ranch, CA 92610-3000 USA
email: info@hamptonproducts.com
www.hamptonproducts.com 1-800-562-5625